

the  
**Key Creator**  
**COOKBOOK**

**A Collection of Recipes**  
**Offering a Brief Introduction to**  
**Computer-Aided Drawing**

using

**KeyCreator 3**

**Jerry Kuhn**

Head Chef

Monadnock Regional High School  
580 Old Homestead Hwy  
Swanzey, NH, 03446

published by **TechEd Concepts, Inc.**, 550 Pembroke St., Pembroke, NH 03275

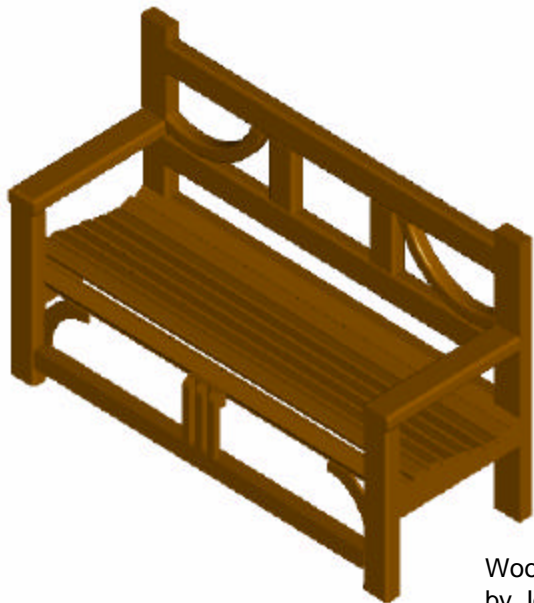

Wood Bench  
by John Pearson  
Courtesy of Oakmont Regional High School, MA



The KeyCreator

# Nutrition Guide

to the Drawings & Curriculum

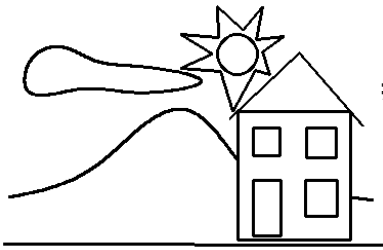

## #1 Landscape 3-21

Creating Basic Entities  
Trims: Divide  
Detailing Text  
Hardcopy Output

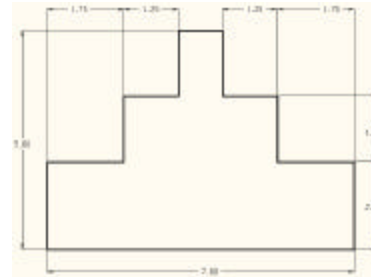

## #7 Tower 8-55

Creating Rectangles  
Creating Parallel lines  
New Trims:  
First, Both, Double  
Linear Dimensioning

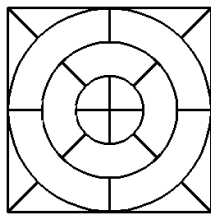

## #2 Target 4-31

The Position Menu  
The Select Menu  
Screen Scaling  
Change Attributes  
Toolbar Control  
Modifying Entities

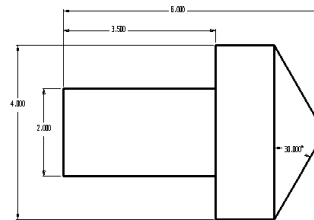

## #8 Spinner 9-65

Trims: Modal  
Creating Angles  
Dimension Angles

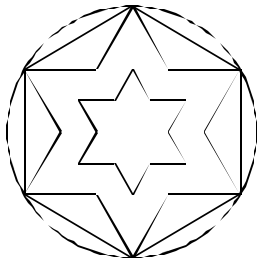

## #3 Polystar 5-39

Creating Polygons  
Line-Strings  
3-Point Circles  
Specifying Text Position

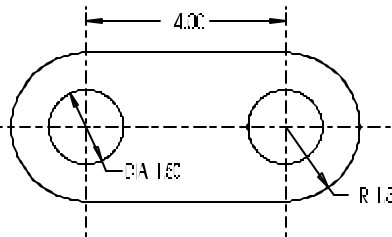

## #9 Pipe Clamp 10-73

Creating Circles  
Creating Arcs  
Dimension Arcs  
Dimension Circles  
Concentricity

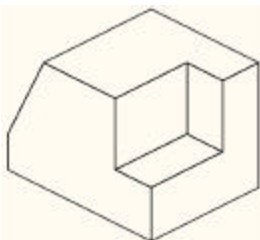

## #4 Bevel Spacer 6-47

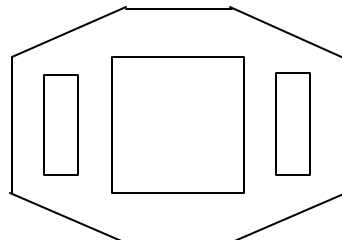

## #5 Base Plate 6-50

Cartesian Co-ordinates  
Key-In Lines

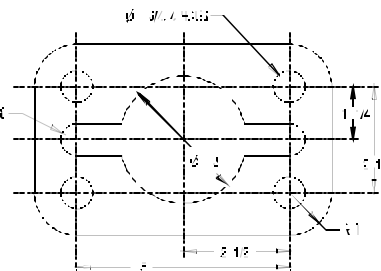

## #10 Key Plate 11-81

Symmetry  
Mirror Commands  
Text Editing  
Dimension Settings  
Dimens. Representation

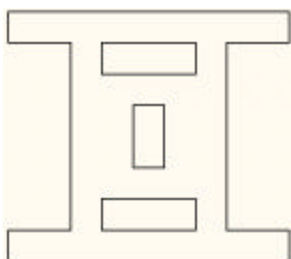

## #6 Extrusion 7-51

Drawing Tools:  
Grid  
Cursor Snap  
Cursor Tracking

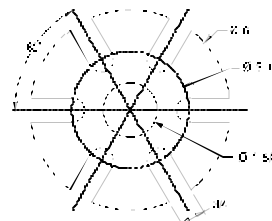

## #11 Slotted Cam 12-89

Rotational Symmetry  
Rotation Commands

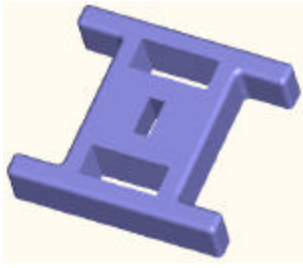

**#12 Extrusion 13-99**

Solids:  
Extrude a Profile  
Render Views  
Boolean Operations  
Difference  
Rotating a View  
Blends.  
Fillet & Rounds

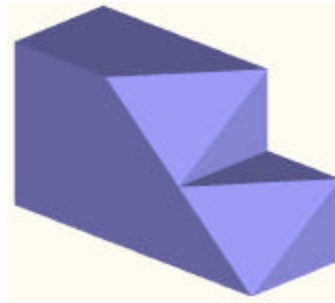

**#17 Locator 18-155**

**#13 Flying Disk 14-113**

Offset Chain  
Revolve a Profile

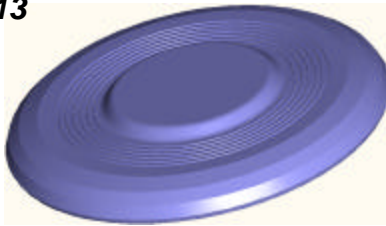

**#18 Sliding Jig 18-159**

Oblique Surfaces  
Define Cutting Planes



**#19 Slide Block 19-167**

Construction Planes  
Auxiliary Views

**#14 Guide Block 15-121**

Multiple Viewports  
Delta Co-ordinates  
Solids:  
Blocks  
Cylinders

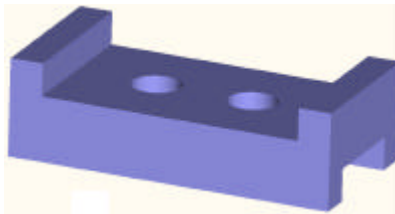

**#20 Clamp Slide 19-172**

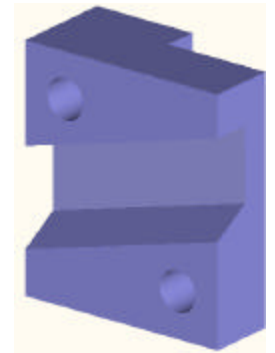

**#15 Sliding Guide 16-131**

Construction Planes

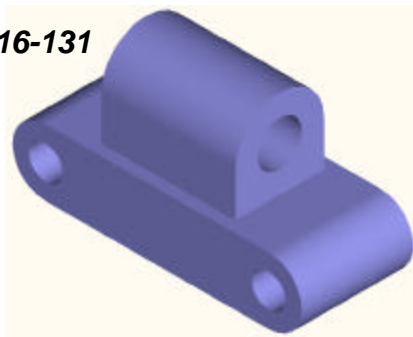

**#21 Slide Clamp 20-177**

Auxiliary Viewports

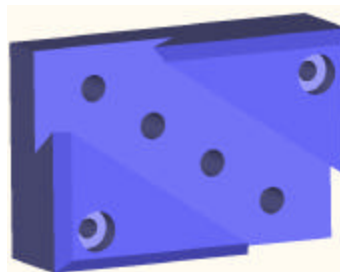

**#16 Dovetail Slide 17-139**

Edit Solids with Lines  
Chamfers  
Normal Surfaces  
Inclined Surfaces  
Drilling Holes

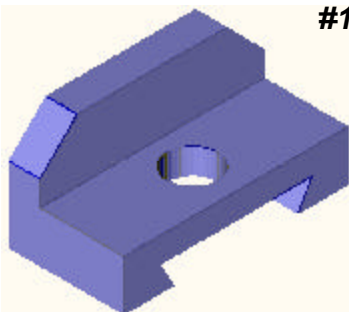

**#22 45° Elbow 21-191**

Pipes  
Sweeps  
Blends

